



Technical Data:
Level CLD / LED / MDT®

Level CLD/LED Controlled Luminance Diffusor: Freestanding uplighter.

Freestanding uplighter with LED, neutral white, 1x 48W or 2x55W, 230V, indirect/direct light emission, single or twin part luminaire head, rotatable by 350°, aluminium profile frame, stove enamelled, diffusor cover with opal enclosed micro prismatic CLD (Controlled Luminance Diffusor) optics, diffusor projecting by 8mm, coated upright, stove enamelled transition profile and base plate, integrated electronic ballast, with head or pole mounted switch, 3m connecting cable with plug. Luminaire available in silver and white.



Single or twin part luminaire head, with head or pole mounted switch.

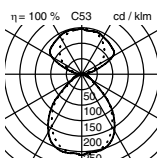

Freestanding uplighter,
350° adjustable, CLD light
directing element, raised,
twin part luminaire head

LED 110W
LL 10500 lm
TCP 4000K
CRI >80
L70 50'000h
UGR<19
Minergie



650°C

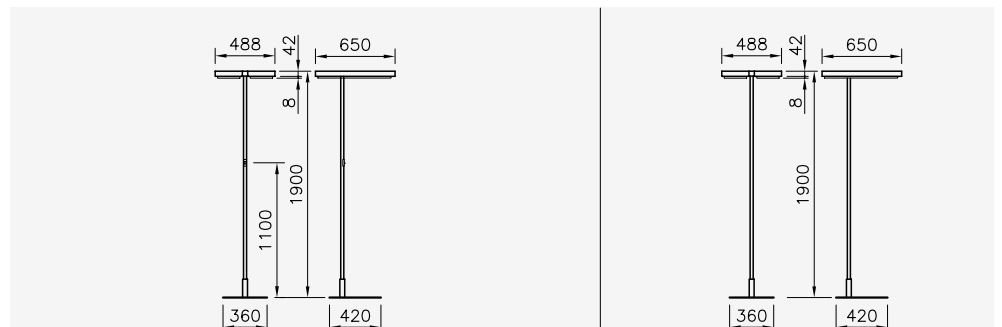

	metallic silver switch on the pole	white switch on the pole	metallic silver switch on lumi- naire head	white switch on lumi- naire head
HF electronic ballast	80L01.120JA	80LW01.120JA	80J01.120JA	80JW01.120JA
HF electronic ballast with dimmer	80L01.120JR	80LW01.120JR	80J01.120JR	80JW01.120JR
HF electronic ballast SensoDim®	80L01.120JS	80LW01.120JS	80J01.120JS	80JW01.120JS

Freestanding uplighter with pole mounted switch.

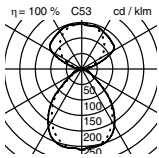

650°C



Freestanding uplighter, 350° adjustable, CLD light directing element, raised, luminaire head left, luminaire suitable for right-handed users, luminaire head right, luminaire suitable for left-handed users

LED 110W

Psys 48W
LL 4600 lm
TCP 4000K
CRI >80
L70 50'000h
UGR<19
Minergie

	left	right		
			metallic silver luminaire head left	white luminaire head right
HF electronic ballast	80L05.60JA	80LW05.60JA	80L06.60JA	80LW06.60JA
HF electronic ballast with dimmer	80L05.60JR	80LW05.60JR	80L06.60JR	80LW06.60JR
HF electronic ballast SensoDim®	80L05.60JS	80LW05.60JS	80L06.60JS	80LW06.60JS

Freestanding uplighter with head mounted switch.

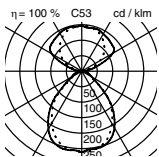

650°C



Freestanding uplighter, 350° adjustable, CLD light directing element, raised, luminaire head left, luminaire suitable for right-handed users, luminaire head right, luminaire suitable for left-handed users

LED 48W

Psys 48W
LL 4600 lm
TCP 4000K
CRI >80
L70 50'000h
UGR<19
Minergie

	left	right		
			metallic silver luminaire head left	white luminaire head right
HF electronic ballast	80J05.60JA	80JW05.60JA	80J06.60JA	80JW06.60JA
HF electronic ballast with dimmer	80J05.60JR	80JW05.60JR	80J06.60JR	80JW06.60JR
HF electronic ballast SensoDim®	80J05.60JS	80JW05.60JS	80J06.60JS	80JW06.60JS

Level CLD Controlled Luminance Diffusor: Freestanding uplighter.

Freestanding uplighter for 2 or 4 x 28W FSDH (TC-LEL) compact fluorescent lamps with 2GX11 lampholder, 230V, indirect/direct light emission, single or twin part luminaire head, rotatable by 350°, aluminium profile frame, stove enamelled, micro prismatic CLD Controlled Luminance Diffusor, coated upright, stove enamelled transition profile and base plate, integrated electronic ballast, with head or pole mounted switch, 3m connecting cable with plug. Luminaire available in silver and white.



Twin part luminaire head, with head or pole mounted switch.

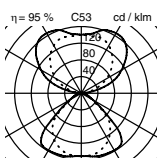

Freestanding uplighter,
350° adjustable, CLD light
directing element,
twin part luminaire head

4x28W
FSDH, 2GX11
UGR<19
Minergie



650°C

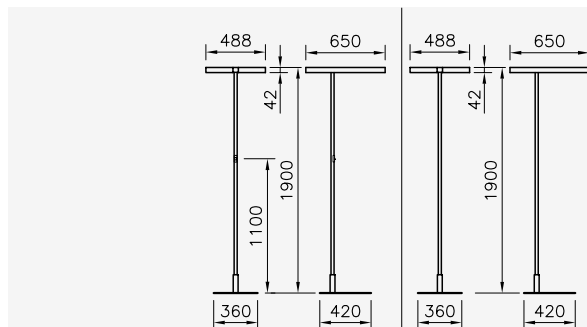

	metallic silver switch on the pole	metallic silver switch on lumi- naire head
HF electronic ballast	80L01.P428.7	80J01.P428.7
HF electronic ballast with dimmer	80L01.P428.R	80J01.P428.R
HF electronic ballast SensoDim®	80L01.P428.S	80J01.P428.S

Freestanding uplighter with pole mounted switch.

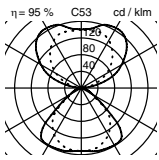

650°C



Freestanding uplighter,
350° adjustable, CLD
light directing element,
raised, luminaire head
left, luminaire suitable
for right-handed users,
luminaire head right,
luminaire suitable for left-
handed users

2x28W
FSDH, 2GX11
UGR<19
Minergie

	left	right
	metallic silver luminaire head left	metallic silver luminaire head right
HF electronic ballast	80L05.P228.7	80L06.P228.7
HF electronic ballast with dimmer	80L05.P228.R	80L06.P228.R
HF electronic ballast SensoDim®	80L05.P228.S	80L06.P228.S

Freestanding uplighter with head mounted switch.

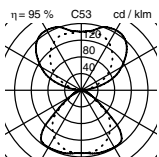

650°C



Freestanding uplighter,
350° adjustable, CLD
light directing element,
raised, luminaire head
left, luminaire suitable
for right-handed users,
luminaire head right,
luminaire suitable for left-
handed users

2x28W
FSDH, 2GX11
UGR<19
Minergie

	left	right
	metallic silver luminaire head left	metallic silver luminaire head right
HF electronic ballast	80J05.P228.7	80J06.P228.7
HF electronic ballast with dimmer	80J05.P228.R	80J06.P228.R
HF electronic ballast SensoDim®	80J05.P228.S	80J06.P228.S

Level MDT® Micro Downlight Technologie: Freestanding uplighter.

Freestanding uplighter for 2 fluorescent tubes T5 or 2/4/6 compact lamps TC-LEL. Indirect/direct light emission. Single, or twin part luminaire head, 350° adjustable or fixed. Aluminium profile frame, thermo painted metallic silver. MDT® (Micro Downlight Technologie) light directing element in specular pure aluminium. Translucent film inlay for defined light distribution, Halogen free internal wiring. Profile connector and base plate, thermo painted metallic silver. Matt chrome upright. Integrated HF electronic ballast. With twin rocker switch, dimmer or light/movement sensor SensoDim®. 3 m mains cable with plug.

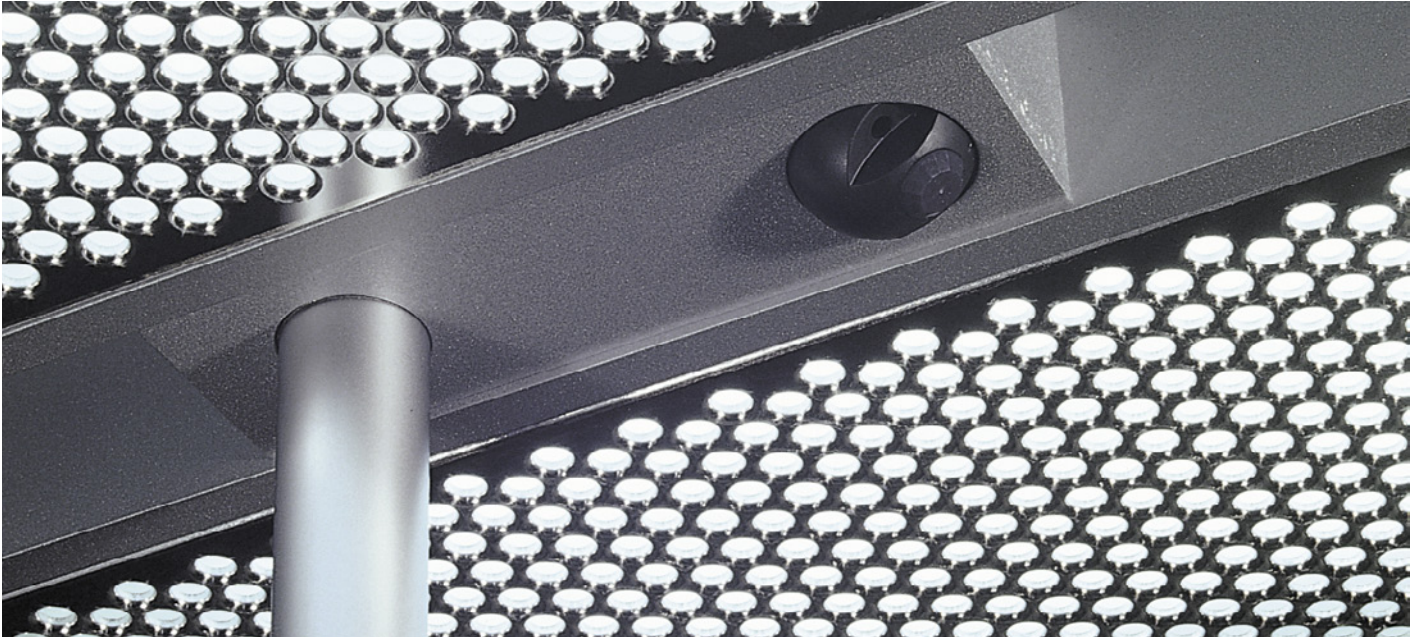

Twin part luminaire head, with head or pole mounted switch.

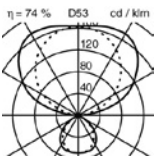

Freestanding uplighter, 350° adjustable, MDT® light directing element, luminaire head, twin part

4x55W
FSDH, 2G11
UGR<19
Minergie



850°C

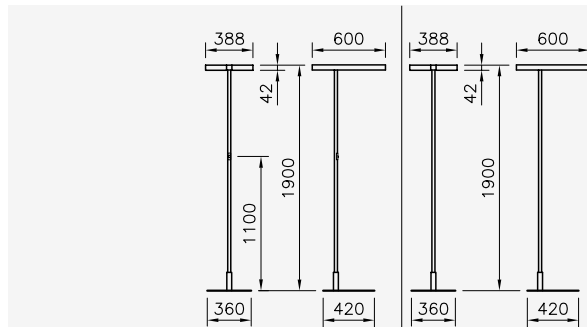

	metallic silver switch on the tube	metallic silver switch on lumi- naire head
HF electronic ballast	80K01.P455.7	80H01.P455.7
HF electronic ballast with dimmer	80K01.P455.R	80H01.P455.R
HF electronic ballast SensoDim®	80K01.P455.S	80H01.P455.S

Freestanding uplighter.

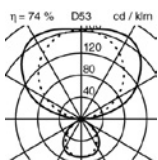

Freestanding uplighter,
350° adjustable, MDT®
light directing element,
raised, luminaire head
left, luminaire suitable
for right-handed users,
luminaire head right,
luminaire suitable for left-
handed users



850°C



2x55W
FSDH, 2G11
UGR<19
Minergie

	left	right
	metallic silver luminaire head left	metallic silver luminaire head right
HF electronic	80H05.P255.7	80H06.P255.7
HF electronic ballast with dimmer	80H05.P255.R	80H06.P255.R
HF electronic ballast SensoDim®	80H05.P255.S	80H06.P255.S

Freestanding uplighter.

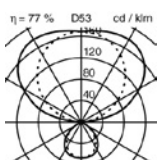

Freestanding uplighter,
350° adjustable, MDT®
light directing element,
raised, luminaire head
left, luminaire suitable
for right-handed users,
luminaire head right,
luminaire suitable for left-
handed users



850°C



2x55W
FSDH 2G11
UGR<19
Minergie

	left	right
	metallic silver luminaire head left	metallic silver luminaire head right
HF electronic ballast SensoDim®	80H07.P255.S	80H08.P255.S

Level MDT® Micro Downlight Technologie: Freestanding uplighter or desk lamp.

Freestanding uplighter or desk lamp for 2 fluorescent tubes T5 or 2/4/6 compact lamps TC-LEL. Indirect/direct light emission. Single or twin part luminaire head, 350° adjustable or fixed. Aluminium profile frame, thermo painted metallic silver. MDT® (Micro Downlight Technologie) light directing element in specular pure aluminium. Translucent film inlay for defined light distribution, Halogen free internal wiring. Profile connector, base plate and desk fixing clamp, thermo painted metallic silver. Matt chrome upright. Integrated HF electronic ballast. With twin rocker switch, dimmer or light/movement sensor SensoDim®. 3 m mains cable with plug.



Single part, aside position.

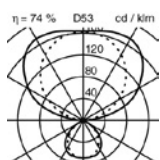

Freestanding uplighter, metallic silver, MDT® light directing element, luminaire head, single part, aside position

4x55W
FSDH, 2G11
UGR<19



850°C

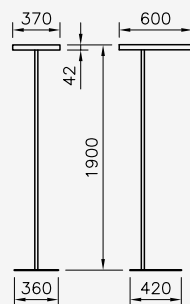

	metallic silver
HF electronic ballast	80H02.P455.7
HF electronic ballast with dimmer	80H02.P455.R
HF electronic ballast SensoDim®	80H02.P455.S

Single part, central position.

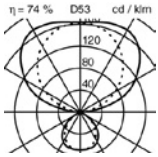

Freestanding uplighter, metallic silver, MDT® light directing element, luminaire head, single part, central position

4x55W
FSDH, 2G11
UGR<19



850°C

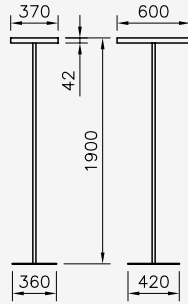

	metallic silver
HF electronic ballast	80H03.P455.7
HF electronic ballast with dimmer	80H03.P455.R
HF electronic ballast SensoDim®	80H03.P455.S

Desk lamp with fixing clamp.

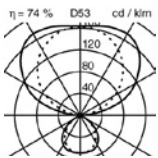

Desk lamp, with fixing clamp, metallic silver, 350° adjustable, MDT®, luminaire head, twin part

4x55W
FSDH, 2G11
UGR<19



850°C

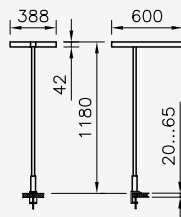

	metallic silver luminaire head twin part
HF electronic ballast	80H61.P455.7
HF electronic ballast SensoDim®	80H61.P455.S

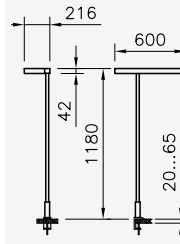

	metallic silver luminaire head single part
HF electronic ballast	80H65.P255.7
HF electronic ballast SensoDim®	80H65.P255.S



Desk lamp, with fixing clamp, metallic silver, 350° adjustable, MDT®, luminaire head, single part

2x55W
FSDH, 2G11
UGR<19

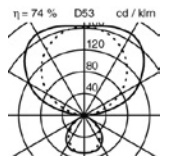

850°C

Level CLD Controlled Luminance Diffusor: Surface-mounted and pendant luminaires.



Ceiling mounted luminaire CLD.

Ceiling mounted luminaire for 1 / 2 x 28/54W or 35/49W FDH (T16) compact fluorescent lamps with G5 lampholder, 230V, indirect/direct light emission, aluminium profile frame, stove enamelled in metallic silver, micro prismatic CLD Controlled Luminance Diffusor, halogen free internal luminaire wiring, integrated electronic ballast.

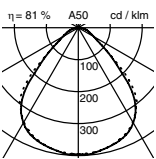
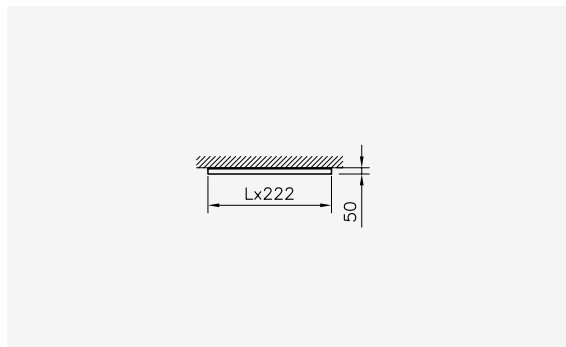

Ceiling mounted luminaire, metallic silver, CLD

FDH, G5
UGR<19



65°C

	L = 1210 mm	L = 1510 mm
HF electronic ballast Detec single lamp	28/54W 80J31.M12.7	35/49W 80J31.M15.7
HF electronic ballast Detec twin lamp	2x28/54W 80J31.D12.7	2x35/49W 80J31.D15.7

Wall mounted luminaire CLD.

Wall mounted luminaire for 2 x 28W FSDH (TC-LEL) compact fluorescent lamps with 2GX11 lampholder, 230V, indirect/direct light emission, aluminium profile frame, stove enamelled in metallic silver, micro prismatic CLD Controlled Luminance Diffusor, metallic silver stove enamelled wall bracket, integrated electronic ballast.

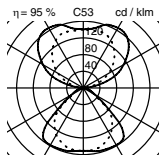
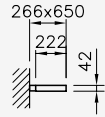

Wall mounted luminaire, metallic silver, CLD

2x28W
FSDH, 2GX11
UGR<19



650°C



	metallic silver
HF electronic ballast	80J20.P228.7

Pendant luminaire CLD.

Pendant luminaire for 1 / 2 x 28/54W or 35/49W FDH (T16) compact fluorescent lamps with G5 lampholder, 230V, indirect/direct light emission, aluminium profile frame, stove enamelled in metallic silver, micro prismatic CLD Controlled Luminance Diffusor, halogen free internal luminaire wiring, integrated electronic ballast, universal ceiling mounting system, sliding fixing wire suspension.

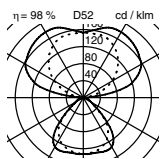
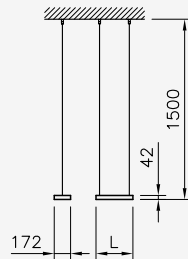

Pendant luminaire, metallic silver, CLD light directing elemen, Wire cord suspension included

FDH, G5
UGR<19



650°C

	L = 1210 mm	L = 1510 mm
HF electronic ballast Detec single lamp	28/54W 80J40.M12.7	35/49/80W 80J40.M15.7
HF electronic ballast Detec twin lamp	2x28/54W 80J40.D12.7	2x35/49W 80J40.D15.7

Level MDT® Micro Downlight Technologie: Surface-mounted or pendant luminaires.

Pendant or system luminaire for 1/2/4 fluorescent tubes T5 or 2/4/6 compact lamps TC-LEL. Indirect/direct light emission. Single or twin part luminaire head, adjustable or fixed. Frame in aluminium profile, thermo painted metallic silver. MDT® (Micro Downlight Technology) light directing element in specular pure aluminium. Translucent film inlay for defined light distribution. Halogen free internal wiring. Rod suspension and canopy, thermo painted metallic silver. Pendant luminaire: wire suspension L=1500mm, with wire cord retainer for self-lock. Integrated HF electronic ballast or light/movement sensor SensoDim®. Optional with dust cover in clear safety glass. System components to be ordered separately. All models available as analogue (.8), digital DALI (.9) dimmable or with TouchDim (.T).

Wall mounted luminaire MDT®.

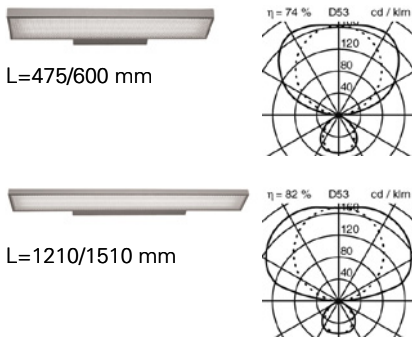

⊕
▽
850°C

Wall mounted luminaire, met. silver, MDT® light directing element
UGR<19



	L = 475 m	L = 600 mm	L = 1210 mm	L = 1510 mm
HF electronic ballast	2x36W FSD 2G11 80H20.P236.7	2x55W FSDH 2G11 80H20.P255.7 Minergie		2x80W FDH G5 80H20.280.7
HF electronic ballast Detec			28/54W FDH G5 80H20.D12.7	35/49W FDH G5 80H20.D15.7

Pendant luminaire MDT®.

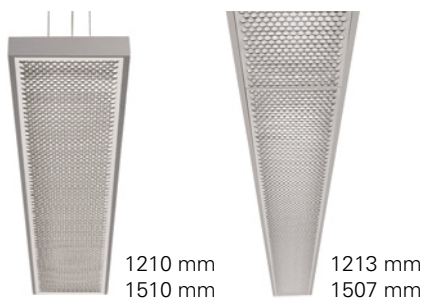

⊕ 850°C

Pendant luminaire, metallic silver, MDT® light directing element. Wire cord suspension included
FDH, G5
UGR<19

850°C



⌀12 80SAW.06
Wire cord suspension, form Y, for pendant luminaire 80H45, Load max. 20 kg

80ET.SET
End caps set, metallic silver, (for pendant luminaire 80H45, 2 pieces

Dust protection cover, clear
28/54W L=1160 mm 80GLS.01
35/49/80W L=1460 mm 80GLS.02

	L = 1210 mm	L = 1510 m	L = 1213 mm	L = 1507 mm
HF electronic ballast		2x80W 80H40.280.7		2x80W 80H45.280X.7
HF electronic ballast Detec	2x28/54W 80H40.D12.7 2x28W Minergie 28/54W 80H40.M12.7	35/49/80W 80H40.M15.7 2x35/49W 80H40.D15.7	28/54W 80H45.M12X.7 2x28/54W 80H45.D12X.7	35/49/80W 80H45.M15X.7 2x35/49W 80H45.D15X.7
HF electronic ballast Detec reg. DALI			28/54W 80H45.M12X.9 2x28/54W 80H45.D12X.9 for SensoDim®-Modul	35/49/80W 80H45.M15X.9 2x35/49W 80H45.D15X.9 2x80W 80H45.280X.9 for SensoDim®-Modul

Pendant luminaire MDT®.

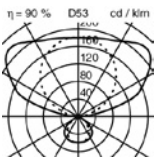

Pendant luminaire, metallic silver, MDT® light directing element, wire cord suspension included

FDH, G5
UGR<19



850°C

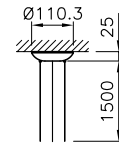
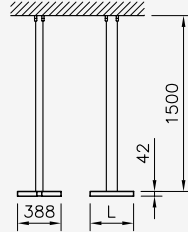

BAL.0005

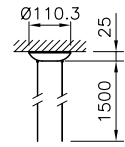

BAL.0006

BAL.0005

Wire cord suspension, for pendant luminaire 80H30, with cable entry. load max. 20 kg

BAL.0006

Wire cord suspension, for pendant luminaire 80H30, without cable entry. load max. 20 kg

MS80H30

Profile connector, metallic silver, for pendant luminaire 80H30, L=1500 mm, adjustable 20-550 mm

	L = 1210 mm	L = 1510 mm
HF electronic ballast Detec	2x28/54W 80H30.D12.7 4x28/54W 80H30.Q12.7	2x35/49/80W 80H30.D15.7 4x35/49W 80H30.Q15.7
HF electronic ballast		4x80W 80H30.480.7

Pendant luminaire MDT®.



EVG



EVG
Detec

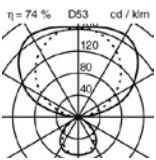

Pendant luminaire, metallic silver, MDT® light directing element, wire cord suspension included

FSDH, 2G11
UGR<19



850°C

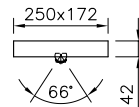
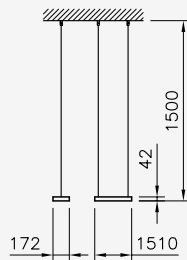

80H45X.S

SensoDim®-Modul, metallic silver
SensoDim® sensor + control unit

	L = 1510 mm
HF electronic ballast	4x55W Minergie 80H41.P455.7
HF electronic ballast SensoDim®	4x55W Minergie 80H41.P455.S







Switzerland
Head Office
Regent Beleuchtungskörper AG
Dornacherstrasse 390
Postfach 246
CH-4018 Basel
Tel. +41 (0)61 335 51 11
Fax +41 (0)61 335 52 01
info.bs@regent.ch

Berne
Regent Beleuchtungskörper AG
Jupiterstrasse 15
Postfach 35
CH-3000 Bern 15
Tel. 031 940 10 10
Fax 031 940 10 11
info.be@regent.ch

Geneva
Régent Appareils d'éclairage SA
Rue de Saint-Jean 30
CH-1203 Genève
Tél. 022 340 34 00
Fax 022 340 38 82
info.ge@regent.ch

Lausanne
Régent Appareils d'éclairage SA
Chemin du Rionzi 60
Case postale 432
CH-1052 Le Mont-sur-Lausanne
Tél. 021 642 02 02
Fax 021 648 21 19
info.ls@regent.ch

Lugano
Regent Illuminazione SA
Via al Mulino 22
CH-6814 Cadempino
Tel. 091 966 77 33
Fax 091 967 11 01
info.ti@regent

Zurich
Regent Beleuchtungskörper AG
Luggwegstrasse 9
CH-8048 Zürich
Tel. 044 497 31 11
Fax 044 497 31 61
info.zh@regent.ch

Head Office International
Regent Beleuchtungskörper AG
Dornacherstrasse 390
P.O. Box 246
CH-4018 Basel Switzerland
Tel. +41 61 335 54 82
Fax +41 61 335 55 96
export.bs@regent.ch

Germany
Regent Licht GmbH
TechnologiePark
Friedrich-Ebert-Straße
D-51429 Bergisch Gladbach
Tel. +49 2204 84 37 80
Fax +49 2204 84 37 81
info@regent-licht.de

France
Régent Appareils d'éclairage Sàrl
Siège social
10, place Charles Béraudier
F-69428 Lyon Cedex 03

Régent Appareils d'éclairage SA
Siège commercial
Dornacherstrasse 390
Case postale 246
CH-4018 Bâle Suisse
Tél. +41 61 335 54 83
Fax +41 61 335 55 96
info.fr@regent.ch

Israel
Regent Lighting Ltd.
4, Moshe Sharet St.
IL-75704 Rishon Letzion
Tel. +972 3 962 29 70
Fax +972 3 962 29 98
service@regentlighting.co.il

Italy
Regent Illuminazione s.r.l.
Sede legale
Via Vittor Pisani 16
I-20124 Milano

Regent Illuminazione SA
Sede commerciale
Via al Mulino 22
CH-6814 Cadempino
Tel. +41 91 966 77 33
Fax +41 91 967 11 01
info.it@regent.ch

Austria
Regent Licht GmbH
Karl-Farkas-Gasse 22
A-1030 Wien
Tel. +43 1 879 12 10
Fax +43 1 879 12 09
info@regent-licht.at

United Kingdom
Regent Lighting UK Ltd.
Legal address
8 Lincoln's Inn Fields,
UK-London, WC2A 3BP
Tel. +44 7515 28 65 37
Fax. +44 208 446 96 09
info@regent-lighting.co.uk

India
Regent Lighting Asia Private Limited
A-40, Ground Floor,
Sector-80, Phase-II,
Noida-201 305, Uttar Pradesh, India
Tel +91 120 473 3028 (North India)
Tel +91 120 473 3031 (South & West
India)
info@regent-lighting.in